

az
ha

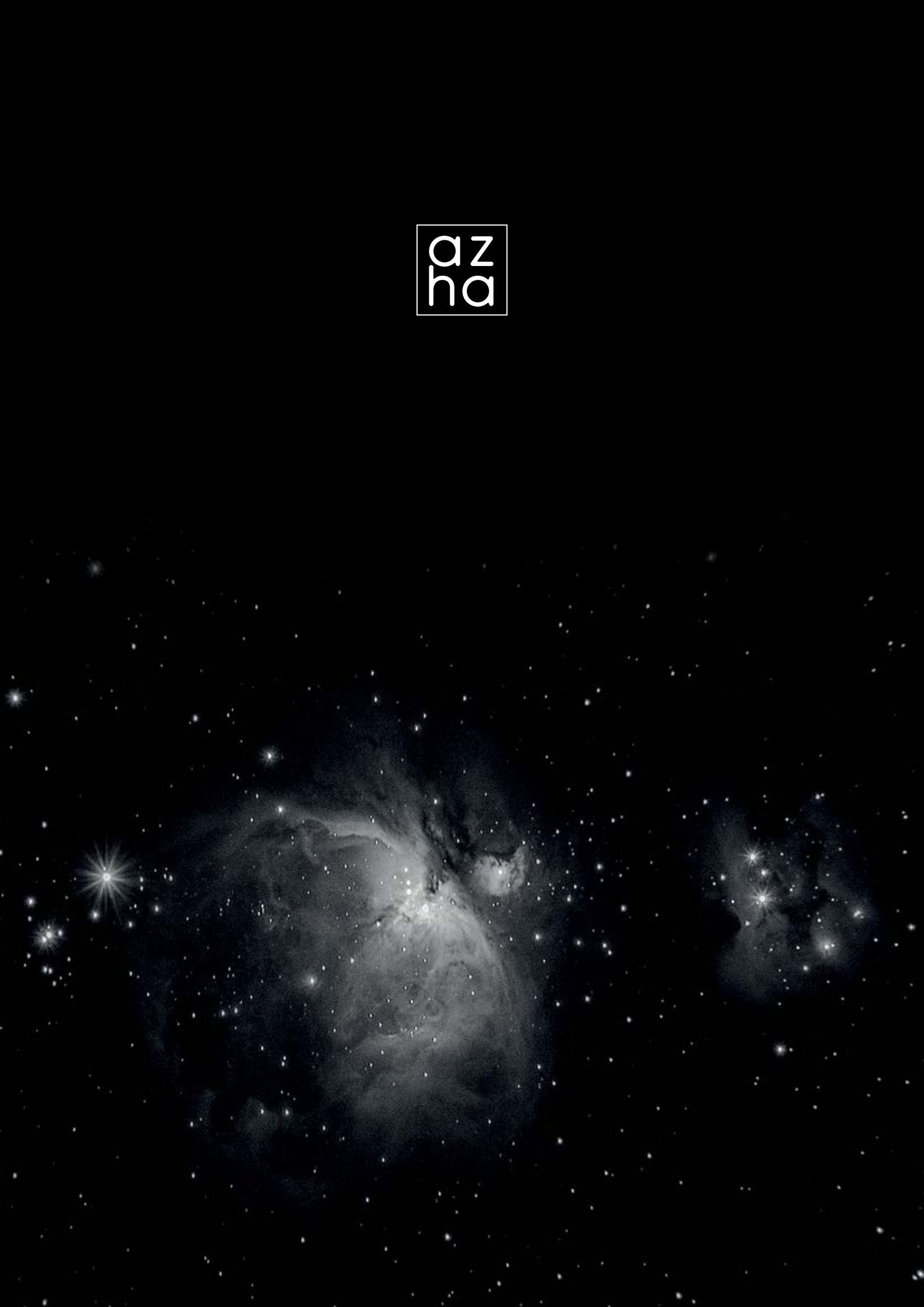

CONTEXT

STRONG & INCISIVE. IDENTITY & CHARACTER.

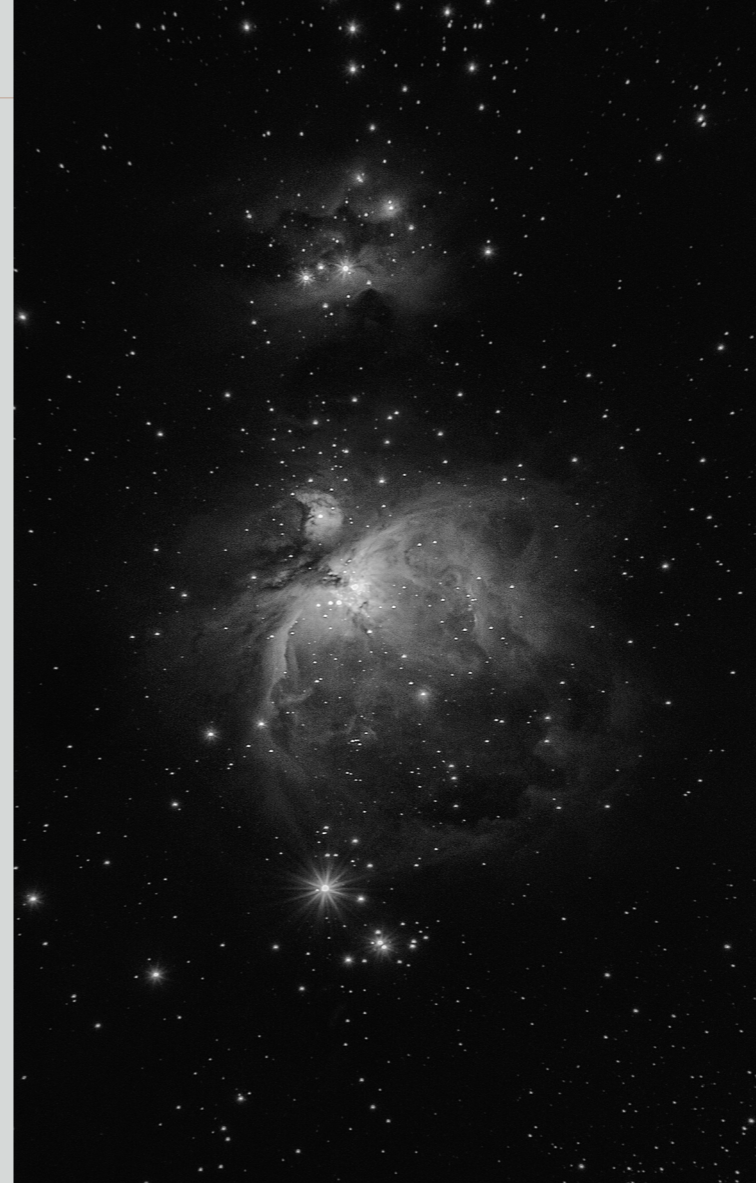

Azha, named after a giant star in the constellation of Eridanus, is a design brand of cosmetics for body & hair.



COSMETIC OVERVIEW

Azha cosmetic collection is formulated with gentle ingredients and botanical extracts, such as Alfalfa and Mallow organic extract, Echinacea, Verbena and Watercress extracts. The body cream is enriched with Vitamin E and Shea butter, the conditioner is enriched with purified keratin and Chamomile extract. Discover the full body and bath collection made in Italy, clinically tested, without mineral oils or phenoxyethanol.



AUTHENTIC DESIGN AND SMART ENGINEERING.

Azha cosmetic collection stands out due to its new dispenser solution which is the result of a fruitful design collaboration between Palomba Serafini studio and Gfl's design department. The creation is a perfect balance of elegant design and outstanding functionality. *The aim of the project is to offer an extremely aesthetic solution, flexible in its configurations and consistent with Gfl's philosophy that is increasingly attentive to the issues of environmental sustainability and the circular economy.*



EXCLUSIVELY
DESIGNED FOR GFL BY

ps+a

ludovica + roberto palomba

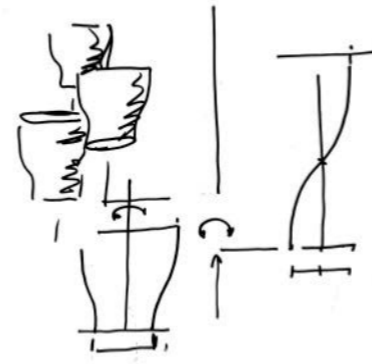

ELEGANCE AND SUSTAINABILITY

Conceived to be an iconic piece of furniture, the Azha **"shelf system"** consists of two simple elements that hide the technical components of safety and functionality inside. The recycled ABS shelf is an interesting novelty both due to its functionality and the use of materials. The bottle, made of recycled plastic (92%) and 100% recyclable, is extremely ergonomic, safe and versatile.

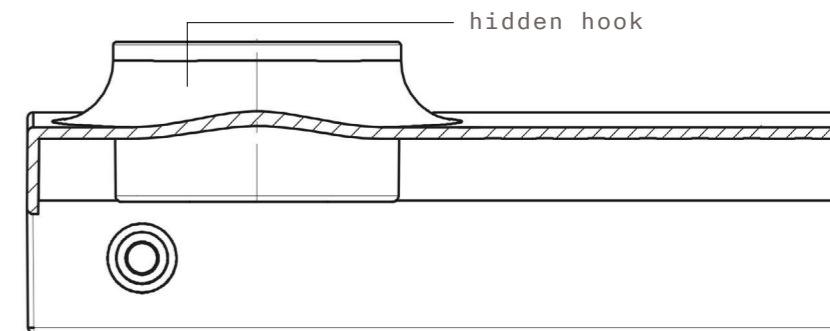

recycled ABS
100% recyclable

DESIGNED FOR USE

In addition to being an elegant dispenser, the shelf, in its long version, is designed to offer an additional support surface for personal objects.

Each creation is the result of coherent research, developing from an interaction of thoughts, inspirations and intuitions. Refusing any linear approach as well as all aesthetic and formal stylisms, Palomba and Serafini rediscover what being a designer means, thinking about the objects' function before designing their shape.



FSS300SAZ
300 ml e 10,14 fl.oz
SHAMPOO
with Watercress extract

SHAMPOO
con estratto di Crescione d'acqua
SHAMPOOING
aux extraits de Cresson d'Eau
HAARSHAMPOO
mit Brunnenkresse-Extrakten
CHAMPÚ
con extractos de Berro de Agua

FSS300MAZ
300 ml e 10,14 fl.oz
HAIR & BODY WASH
with Echinacea and Verbena
organic extracts

SHAMPOO DOCCIA
con estratti biologici di Echinacea
e Verbena
GEL CORPS ET CHEVEUX.
avec des extraits biologiques de
fleurs Echinacée et de Verveine
DUSCHGEL & SHAMPOO
mit biologischen Extrakten des
Sonnenhuts und Eisenkrauts
GEL-CHAMPÚ
con extractos biológicos de
equinácea y Verbena

FSS300BAZ
300 ml e 10,14 fl.oz
BODY WASH
with Alfalfa and Mallow
organic extracts

GEL DOCCIA
con estratti biologici di Erba
Medica e Malva
GEL DOUCHE
aux extraits biologiques de
Luzerne et de Mauve
DUSCHGEL
mit biologischen Extrakten
der Luzerne und Malve
GEL DE DUCHA
con extractos biológicos de
Alfalfa y Malva

FSS300CAZ
300 ml e 10,14 fl.oz
CONDITIONER
with purified Keratin
and Camomile extract

BALSAMO
con cheratina purificata e
estratto di Camomilla
APRÈS-SHAMPOOING
à la kératine purifiée et aux
extraits de camomille
HAARSPÜLUNG
mit Keratin und Kamillenex-
trakten
ACONDICIONADOR
con queratina purificada y
extractos de manzanilla

FSS300BLAZ
300 ml e 10,14 fl.oz
BODY LOTION
with Vitamin E and Shea Butter

CREMA CORPO
Con vitamina E e burro di Karité
CRÈME HYDRATANTE MAINS
ET CORPS
à la vitamine E et au beurre de karité
KÖRPERCREME
mit Vitamin E und Sheabutter
LECHE CORPORAL
con vitamina E y manteca de karité

FSS300LMAZ
300 ml e 10,14 fl.oz
LIQUID HAND SOAP
with Guarana extract

SAPONE LIQUIDO
con estratto di Guaraná
SAVON LIQUIDE
avec des extraits de Guarana
FLÜSSIGE SEIFE
mit Guarana-Extrakten
JABÓN LÍQUIDO
con extractos de Guaraná

BACK



Cosmetic Specifications

-
- Ni
- V
-
- BHT
- fl/fr

-
-
-
-
-
- W/Fl

-
-
-
-
-
- Fl/C

-
-
-
-
-
- W/Fl

-
-
-
-
-
- Fl/C

-
-
-
-
-
- Fl/C

- Dermatologically tested
- Nickel tested
- Vegan friendly
- No alcohol
- No petrolatum
- No BHT
- Fragrance

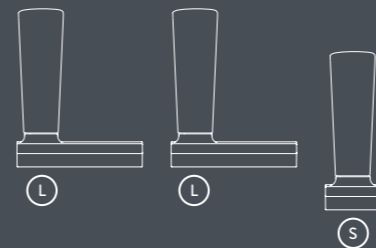
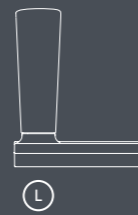
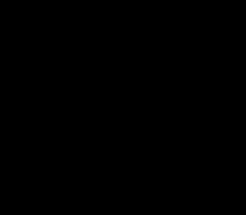
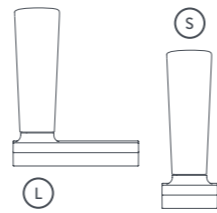
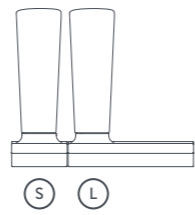
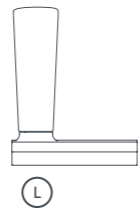
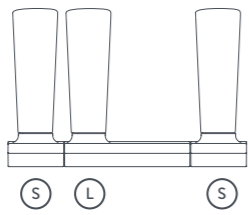
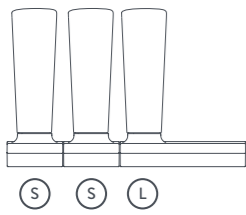
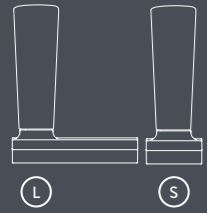

PLAY AND MATCH

Azha shelf system is extremely versatile and adaptable to many contexts and spaces. The shelf bases are available in two sizes: short and long. By combining the two formats, many combinations can be obtained.

Ⓢ Short Holder

Ⓛ Long Holder

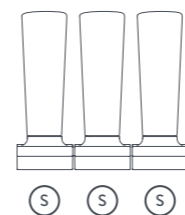
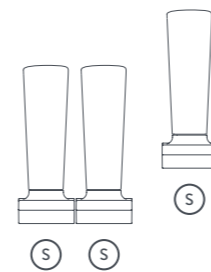



SP092AZ
7x7x3 cm

KONJAC SPONGE
with bamboo charcoal

SPUGNA KONJAC
con carbone di bambù
EPONGE DE KONJAC
au charbon de bambou
KONJAC-SCHWAMM
mit Bambuskohle
ESPONJA KONJAC
con carbón de bambú



Packaging Specifications



Caps made of recycled PP
Tappi realizzati in PP riciclato
Bouchons fabriqués en plastique PP recyclé
Verschlüsse aus recyceltem PP
Tapones realizados con PP reciclado



100% recycled PET
PET 100% riciclato
PET 100 % recyclé
100% recycled PET
PET 100% reciclado



PE Label
Etichetta in PE
Etiquette en PE
PE Etikett
Etiqueta de PE



Caps made of recycled PP
Tappi realizzati in PP riciclato
Bouchons fabriqués en plastique PP recyclé
Verschlüsse aus recyceltem PP
Tapones realizados con PP reciclado



92% recycled PE
PE 92% riciclato
PE 92% recyclé
92% recycled PE
PE 92% reciclado



PE Label
Etichetta in PE
Etiquette en PE
PE Etikett
Etiqueta de PE



ABS Holder
Staffa di supporto in ABS
ABS Support
ABS Wandhalterung
Soporte en ABS



Soap wrapped in PP (20g - 40g)
Incarto saponi in PP
Savon enveloppé en PP
Seife eingewickelt in PP
Jabón envuelto en PP



All 100 % Recyclable
Tutto 100% Riciclabile
Tout 100% recyclable
Alles 100% recycelbar
Todo 100% reciclable

Shelf System



SHORT HOLDER

Staffa di supporto corta
Support court
Kurze Wandhalterung zum Schrauben
Soporte corto

White **SSC#BI**
Gunmetal Gray **SSC#CF**
Black **SSC#NE**

Recommended color: WHITE



LONG HOLDER

Staffa di supporto lunga
Support long
Lange Wandhalterung zum Schrauben
Soporte largo

White **SSL#BI**
Gunmetal Gray **SSL#CF**
Black **SSL#NE**

Recommended color: WHITE

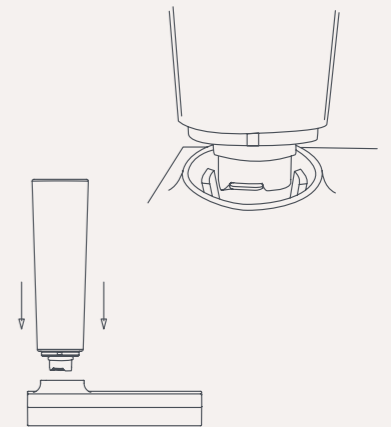

Installation & Maintenance



Install with screw
Installazione con viti
Installation à vis
Mit Schrauben installieren
Instalación con tornillos



Easy to combine in multiple arrangements. Download the instruction sheet here.
Facile da comporre in svariate combinazioni. Scarica le istruzioni di installazione qui.
Facile à associer en différentes versions. Téléchargez la brochure d'instructions ici.
Einfach zu kombinieren in verschiedenen Arrangements. Laden Sie hier die Bedienungsanleitung herunter.
Fácil de combinar en diferentes soluciones. Descargar las instrucciones aquí.

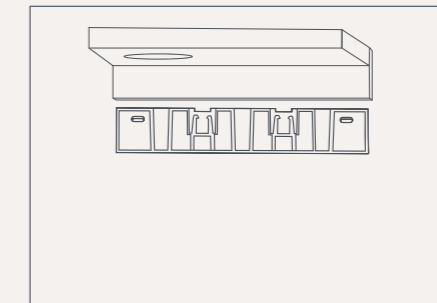
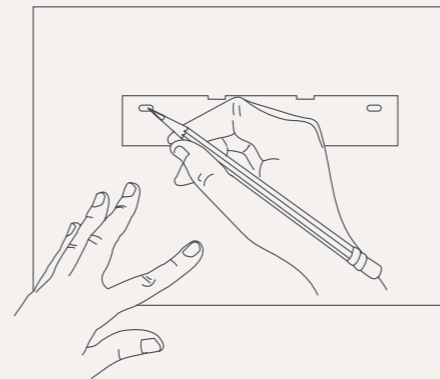

Closure Anti-theft accessible with key
Chiusura antifurto apribile con chiave
Fermeture antivol accessible avec une clé
Diebstahlsicherung mit Schlüssel zu öffnen
Cierre antirrobo accesible con llave

GFL SA

Via Sorengo 1, (CH) 6900 Lugano
T +41(0)91 9607500
F +41(0)91 9607599
info@gflamenities.com
www.gflamenities.com

GFL USA Inc.

205 Hudson St, New York, NY
10013, USA
T +1 (718) 414-2554
info@gflamenities.com
www.gflamenities.com

**GFL Middle East Cosmetics
Trading LLC**

ESPADA business center
Office #17, PO BOX 282556,
502, 5th Floor, Rasis building
Al Barsha 1, Dubai - UAE
T +971 4 315 98 14
info@gflamenities.com
www.gflamenities.com